

69  
**Memorex®**

**PERSONAL CD / CD-R / CD-RW PLAYER  
WITH 45-SECOND DIGITAL  
ANTI SKIP PROTECTION**

**MODEL # MD6446 SERIES SUFFIX A**

**BEFORE OPERATING THIS PRODUCT PLEASE  
READ THESE INSTRUCTIONS COMPLETELY**

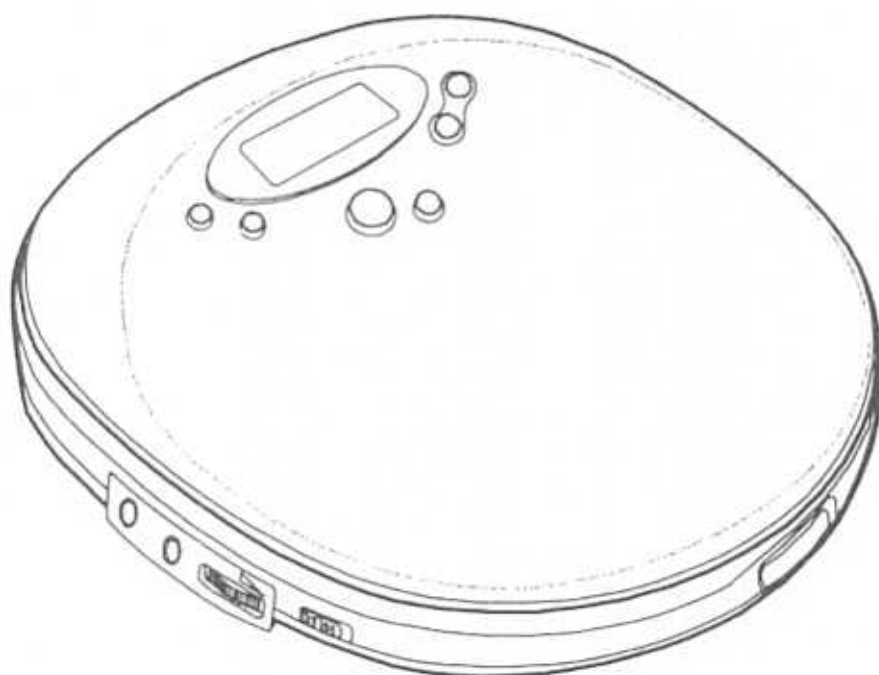

**OPERATING INSTRUCTIONS**

# TABLE OF CONTENTS

WARNING .....	P.1
PRECAUTIONS .....	P.2
LOCATION OF CONTROLS .....	P.3
POWER SOURCES .....	P.4
HEADPHONE AND HI-FI CONNECTION .....	P.5
CAR KIT OPERATIONS .....	P.5
PLAYING A CD IMMEDIATELY .....	P.6 - P.7
OTHER OPERATIONS .....	P.8 - P.10
USING OTHER FUNCTIONS .....	P.10
MAINTENANCE .....	P.11
PRODUCT SPECIFICATIONS .....	P.12
GENERAL INFORMATION .....	P.13

## WARNINGS

TO PREVENT FIRE OR SHOCK HAZARDS, DO NOT EXPOSE THIS UNIT TO RAIN OR MOISTURE.



This symbol is intended to alert the user to the presence of uninsulated " dangerous voltage " within the products enclosure that may be of sufficient magnitude to constitute a risk of electric shock to persons.



This symbol is intended to alert the user to the presence of important operating and maintenance ( servicing ) instructions in the literature accompanying the appliance.



This product utilizes a Class 1 laser to read Compact Discs. This laser Compact Disc Player is equipped with safety switches to avoid exposure when the CD door is open and the safety interlocks are defeated. Invisible laser radiation is present when the CD Player's lid is open and the system's interlock has failed or been defeated. It is very important that you avoid direct exposure to the laser beam at all times. Please do not attempt to defeat or bypass the safety switches.

Any use of the controls or an adjustment to the procedures other than those specified herein may result in hazardous radiation.

TO REDUCE THE RISK OF ELECTRIC SHOCK, DO NOT REMOVE COVER ( OR BACK ). THERE ARE NO USER-SERVICEABLE PARTS INSIDE. PLEASE REFER ANY SERVICING TO QUALIFIED SERVICE PERSONNEL.

## PRECAUTIONS

- Do not open the CD compartment while the CD is rotating.
- Always keep the CD compartment closed when not in use.
- Keep all foreign objects out of the CD compartment.
- If TV or radio interference occurs during operation, move the unit to a different location within the room or building.
- Place the unit on a stable surface. A vibration or shock to the unit can cause the CD mechanism to mistrack or skip. If operating the unit under circumstances which may subject the unit to these conditions, utilize the digital Anti-shock, See page 10.
- Playing some CD's at high volume can cause vibration leading to mistracking. In this case, lower the volume or relocate the speakers further away from the unit.
- Avoid installing the unit in the locations described below :
  - Where it will be in direct contact with water.
  - Where it will be in direct contact with a magnet.
  - Places exposed to direct sunlight or close to heat radiating appliances such as electric heaters.
  - On top of stereo equipment that radiates too much heat.
  - Places lacking ventilation or dusty places.
  - Places subject to constant vibration.
  - Humid or moist places.

## LOCATION OF CONTROLS

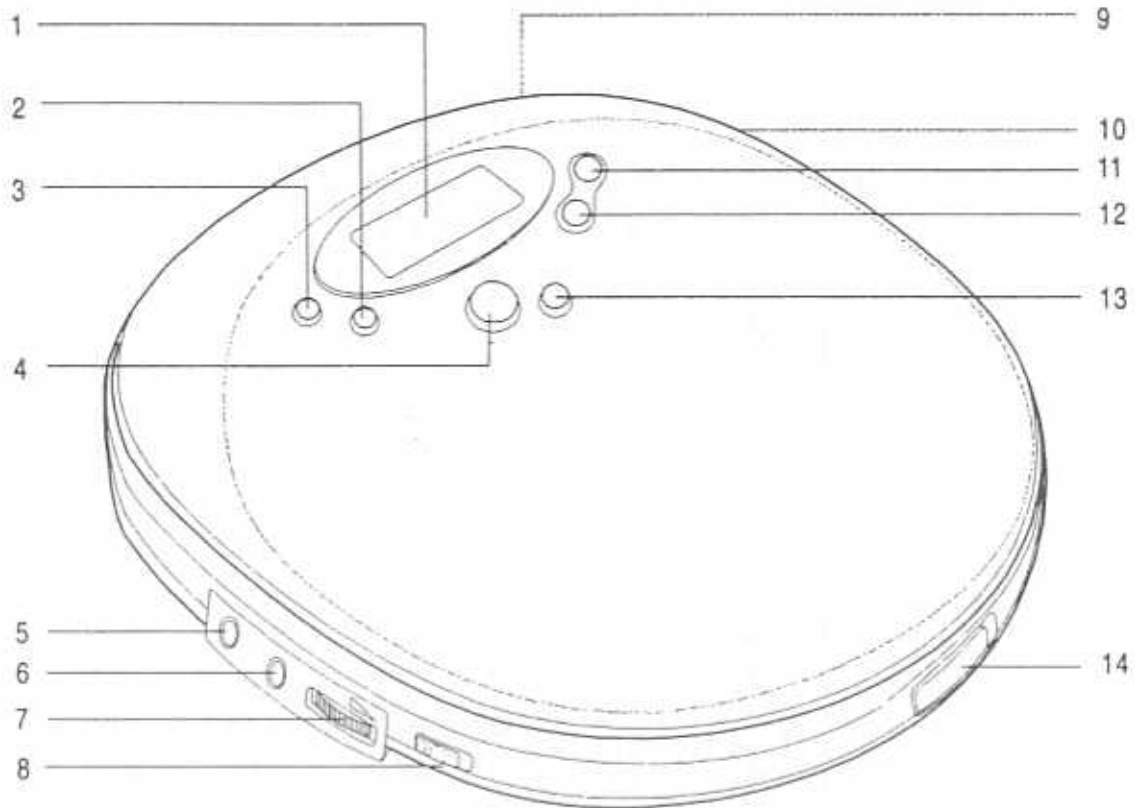

1. LCD WINDOW
2. MODE BUTTON
3. PROG. BUTTON
4. PLAY / PAUSE BUTTON
5. LINE OUT JACK
6. HEADPHONE JACK

7. VOLUME CONTROL KNOB
8. DBBS ( BASS BOOST ) SWITCH
9. DC JACK
10. BATTERY COMPARTMENT
11. 12. SKIP / SEARCH BUTTONS
13. STOP BUTTON
14. DOOR OPEN SWITCH

## POWER SOURCES

### Using Battery (not included)

1. Open the lid of the battery compartment.
2. Insert 2 "AA" Size ( UM-3 ) alkaline batteries by matching the ( + and - ) to the diagram inside the battery compartment and close the lid.

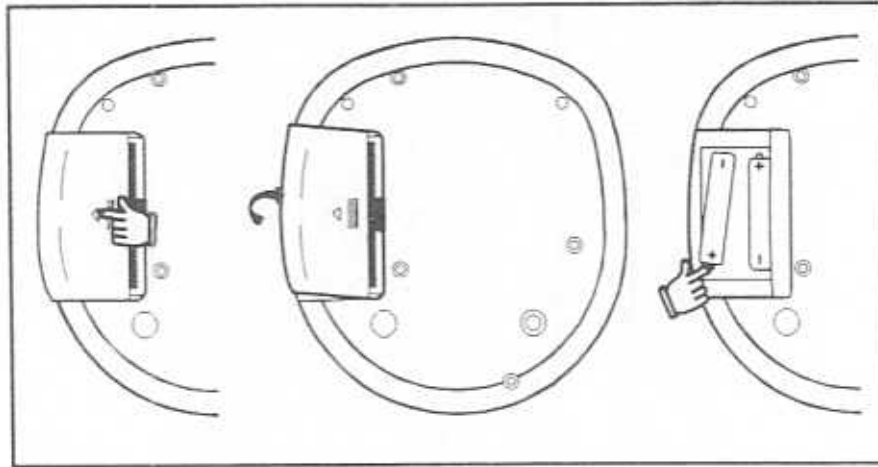

**Note :** For battery operation the AC power adaptor must be disconnected from DC IN jack.

### When to Change the Battery

When the battery is used up, "  " indicator flashes in the LCD display. Replace all the batteries with new alkaline batteries.

**Note :** For battery operation the AC power adaptor must be disconnected from DC in Jack.

### Using on the AC Power Adaptor (supplied or optionally available)

Use only the 4.5V/600mA direct current, positive pole to center pin power adapter. Any other adapter may damage the set.

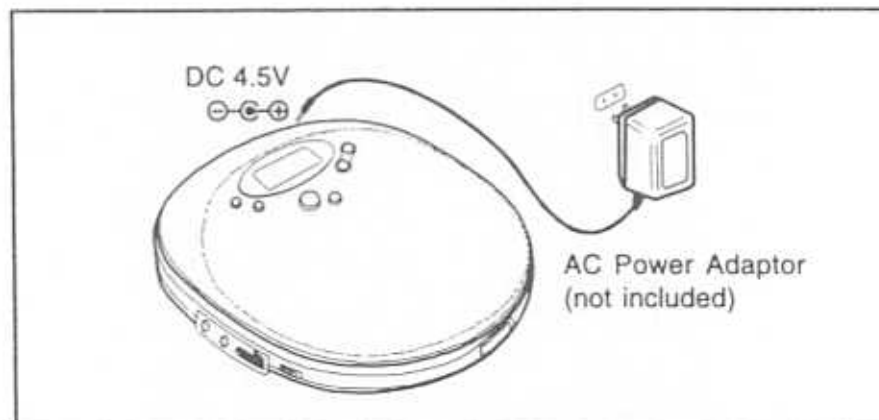

# HEADPHONE AND HI-FI CONNECTION

## Listening with the Headphones

Connect the plug of the stereo headphones ( included ) or earphones ( not included ) into the PHONES ( GREEN ) socket.

Caution : Avoid excessive volume levels and listening to sound for a long period of time when using headphones, as this may impair your hearing.

## Connecting to component audio systems

Connect the patch cord into the LINE OUT ( BLACK ) socket of the unit and the CD / AUX inputs of an audio system.

Note : Always switch the power off before making any connections between the player and another unit.

# CAR KIT OPERATIONS

## ( Connection supplied or optionally available )

The cassette adaptor allows you to use your portable CD player with your car stereo cassette system or portable audio cassette system.

1. Position the cassette adaptor cord so the cord extends out from the cassette player when the cassette is inserted. Insert the cassette adaptor in the same direction as you would insert an audio cassette tape.
2. If the cassette adaptor cord is on the wrong side of the tape, reposition the cord to the opposite corner of the channel.
3. Insert the cassette adaptor stereo plug into the headphones jack on the left side of the CD player.
4. Turn on the cassette player. Press PLAY on the cassette player.
5. Press PLAY on the CD player.
6. Set the volume of the CD player to a mid-level. Adjust the volume of the cassette player.

- Notes :**
- The cassette adaptor has the play head on one side only. If you insert the cassette and no sound is heard, try turning the cassette over or pressing the reverse button to change direction.
  - The car cassette adaptor may not be compatible with all makes and models of cassette players.

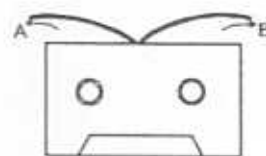

To Cassette Deck



To Headphones Jack

Use the Cigarette Lighter Adaptor for power when using the CD player in a car.

1. Plug the adaptor into the car cigarette lighter.
2. Plug the pin into the DC jack on the unit.

**Notes :** The supplied DC car adaptor / cord is designed for use with vehicles equipped with a 12 volt negative ground electrical system only.



# PLAYING A CD/CD-R/CD-RW IMMEDIATELY

## 1. Connect

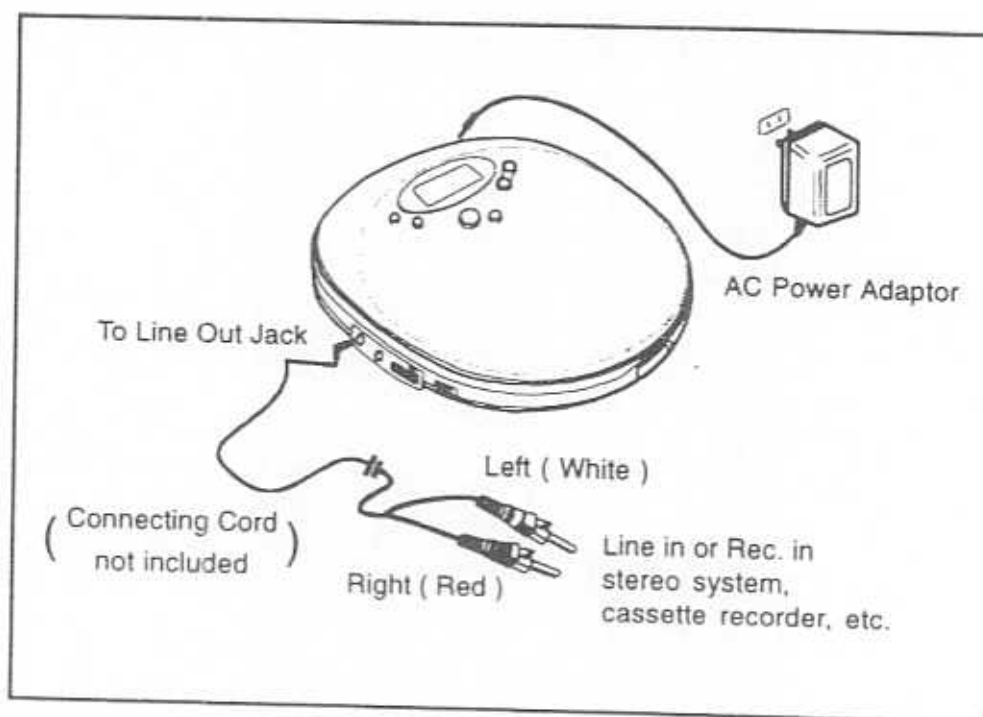

### Note

1. Refer to " Power Sources " for details on using with batteries.
2. Connect the headphones firmly. A loose connection may cause static noise during playback.

## 2. Insert a CD / CD-R / CD-RW disc

Note : Must be use DIGITAL AUDIO CD-RW disc.

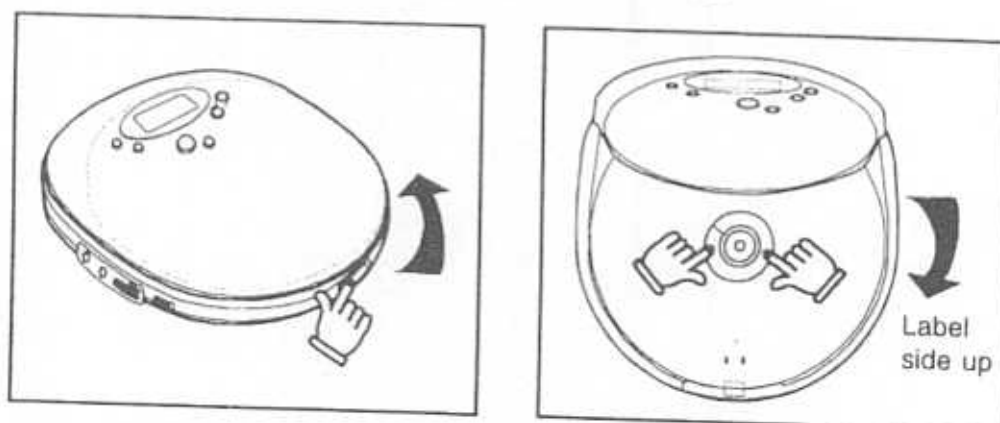

1. Push OPEN button and open the lid.
2. Place the CD firmly on the pivot and close the CD door.



# PLAYING A CD/CD-R/CD-RW IMMEDIATELY

## 3. Play

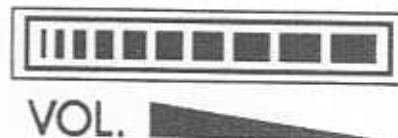
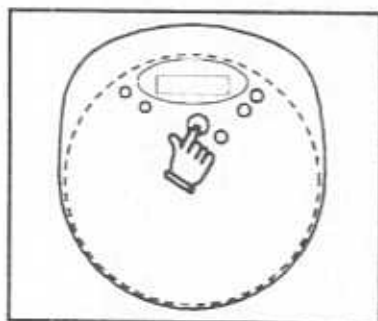

1. Press "▶||" PLAY / PAUSE button.
2. Adjust the Volume control.

To stop play, press "■" STOP button.

To	Press	Display
Pause	▶	05 00:16
Resume play after pause	▶	05 00:17
Find the beginning of current track	◀◀ once	05 00:17 → 05 00:00
Find the beginning of previous track	◀◀ repeatedly	05 00:00 → 04 00:00
Find the beginning of previous track	▶▶ once	05 00:00 → 06 00:00
Find the beginning of succeeding track	▶▶ repeatedly	05 00:00 → 06 00:00 → 07 00:00
Go forward quickly	hold down ▶▶	
Go backward quickly	hold down ◀◀	

## 5. To Remove the CD

Remove the CD while pressing the pivot.

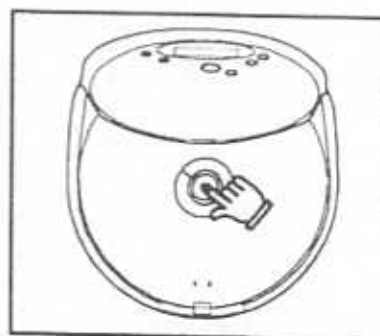



## OTHER OPERATIONS

### Playing Tracks Repeatedly ( Repeat Play )

You can play tracks repeatedly in Normal or Program play modes. Repeat all the tracks or only one track.



### To Repeat a Single Tracks

Press MODE while the track you want to repeat is playing. The " [ ] 1 " indicator will appear in LCD.



- To repeat another track, press " ⏮ " or " ⏭ " SKIP / SEARCH button.
- To cancel repeat play, press MODE button four times.

### To Repeat all the Tracks

Press the MODE button twice during play. The " [ ] ALL " indicator will appear in LCD.



- All tracks will be repeated continuously.
- To cancel repeat play, press MODE button three times.

### Playing only Few Seconds of Each Tracks ( Intro Play )

Play first 10 seconds of all songs.

1. During stop, press MODE button three times. The " INTRO " indicator will appear in LCD.
2. Press " ⏭ " to start scanning. The first 10 seconds of each track will be played.
3. To end intro play and continue with normal play, press MODE button two times.

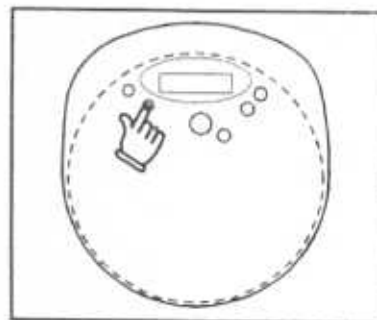

## OTHER OPERATIONS

### Playing Tracks in the Order You Want ( Program Play )

You can program up to 24 tracks to play in any order you choose.

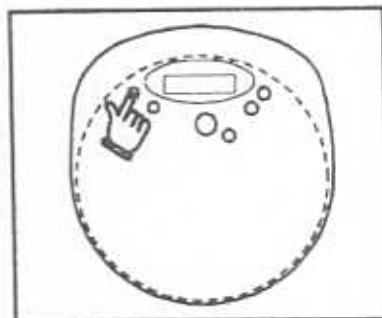

1. During stop, press PROG button until " PROG " flashes in LCD. The track number and playing order appears.



2. Press " ⏮ " or " ⏭ " SKIP / SEARCH button to choose a track.
3. Press PROG button to program the track.
4. Repeat steps 2 and 3 to program tracks.
5. Press " ⏸ " PLAY / PAUSE button. The " PROG " stops flashing and the tracks you choose to play in the order you specified.  
To cancel program play, press " ■ " STOP button or open the door.

### To Check the Program

To check during programming, press " ⏭ " SKIP / SEARCH button. Each time you press " ⏭ " SKIP / SEARCH button, the track numbers appear in the order you specified.

### Playing Tracks in the Random ( Shuffle Play )

During stop, press MODE button four times, the "RAND" indicator will appear in LCD. The track play in random order.



To cancel random play, press MODE button once.

## USING OTHER FUNCTIONS

### To Enjoy More Power Bass Sound

You can enjoy more powerful bass-boosted sound by setting the DBBS switch to ON position.



**Note :** If the sound is distorted when emphasizing bass, turn down the volume.

### “JOGGABLE” ELECTRONIC ANTI-SKIP PROTECTION

This CD player is equipped with an automatic “Joggable” 45 second Electronic Anti-Skip Memory and an Anti-Rolling Mechanism that will eliminate virtually all skipping under normal conditions. The joggable anti-skip circuitry provides a much faster recovery time than previous anti-skip systems. The recovery time is shorter than the time between steps for the average jogger. This means that you can carry this unit while you are jogging and still enjoy skip free music. When you press the PLAY/PAUSE ►|| button to begin playback the player immediately begins to store 45 seconds of music in a solid state memory that is impervious to shock. The player is always reading the disc 45 seconds ahead of the music you are hearing and storing that information in the memory. If the player is subjected to shock or bumps of less than 45 seconds duration you will not notice them at all. If the bumps last longer than 45 seconds the anti-skip memory may be depleted and the player may skip or stop.

When playback begins the Joggable Anti-Skip indicator begins to flash rapidly in the display. When the Anti-Skip memory contains 45 seconds of music and is “full”, the indicator flashes slowly. If the player is bumped or shaken the indicator again flashes rapidly. The player may skip if the bumps continue. When the bumps stop the memory starts to fill up again and the flashing indicator will slow down.



**Note:** Each time you begin playing a disc the joggable anti-skip system will turn ‘On’ automatically.

## MAINTENANCE

### Cleaning the Cabinet

Wipe with a soft cloth. If the cabinet is very dirty, dampen the cloth with a weak solution of neutral detergent and water, and then wipe clean.

### Cleaning the Lens

A dirty lens will cause sound skipping and, if the lens is very dirty, the CD may not work. Open the disc cover and clean the lens as follows :

#### Dust or Dry Particles

Using a camera lens brush / blower, blow on the lens couple times, then wipe it lightly with the brush to remove dust. Then, blow on the lens once more.

#### Fingerprints

If the lens does not get clean using brush / blower, use a cotton swab starting in the middle and working to the outside edge.

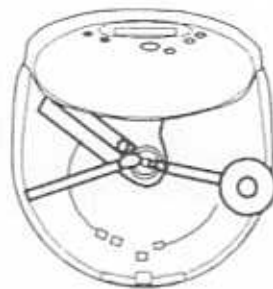

### Cleaning the Disc

When a disc becomes dirty, clean it with a cleaning cloth. Wipe the disc from the centre out.

#### Note :

- Do not use solvents such as benzine, thinner, commercially available cleaners or anti-static spray intended for analog discs.



# PRODUCT SPECIFICATIONS

## AUDIO

Frequency response	20-20,000Hz (+1/-3 dB)
Antishock	45 seconds buffer
Wow and flutter	Below measurable limits
No. of channels	2 channels (stereo)
Output level	Line output : 0.6 Vrms (47 k $\Omega$ ) Headphone : 16mW (32 $\Omega$ )
Bass boost effect (100 Hz)	+ 6dB

## PICK-UP

System	Compact disc digital audio system
Laser diode	Material : GaAlAs
Properties	Wavelength : $\lambda=780\text{nm}$ Emission duration : continuous Laser output : < 44.6 $\mu\text{W}$
Error correction	Cross-interleave Reed-solomon code

## GENERAL

Power requirements	2 x LR6 AA alkaline battery DC in 4.5V jack accepts AC power adaptor (centre positive)
Power consumption	0.8W (DC 3V) Under normal condition
Dimension	Approx. 145 (W) x 28 (H) x 165 (D) mm
Weight	Approx. 260g not including battery

# GENERAL INFORMATION

## Troubleshooting Guide

SYMPTOM	CAUSE	SOLUTION
CD Player will not turn on	Dead or weak batteries	Replace batteries
	AC adaptor not connected properly	Check AC adaptor connection
Disc will not play	Disc inserted incorrectly	Reinsert disc with label side facing up
	Defective compact disc	Try another compact disc
	CD compartment not closed	Close lid securely
	Moisture has formed inside the CD deck	Take out the CD and leave the CD compartment door open for about an hour to dry moisture condensation
No sound from headphones	Headphone plug not inserted properly	Reinsert headphone cord into Headphones jack
	Volume control set to minimum	Increase the volume
	Weak batteries	Replace with fresh batteries, or use AC power
	Defective compact disc	Try another compact disc
Sound is skipping	The compact disc or pickup lens is dirty	Clean or replace the compact disc or clean the pickup lens
	Strong vibrations	Place the CD Player on a level surface that is stable ( no vibrations )

“ CUSTOMER SERVICE : 1-800-919-3647 ”

Memcorp, Inc.  
Weston, FL  
Printed in Hong Kong

Visit our website at [www.memcorpinc.com](http://www.memcorpinc.com)

052MD644655A